

TESTING INSTRUMENTS FOR
A MEASURABLE DIFFERENCE...

IDM
instruments

PACKAGING INDUSTRY INSTRUMENTS



CATALOGUE

ABOUT US

IDM Instruments Pty. Ltd. is a leading manufacturer of testing and measurement instruments. With over 49 years of experience, we have successfully delivered testing solutions to leading global companies.



Since 1972



Testing Standards Accredited



Global Presence



Custom Manufacturing



Lifetime support



1-year Warranty



Calibration & Maintenance



Trusted by Leaders

KEY BUSINESS AREAS

We are proudly Australian owned and managed. Started in a humble garage in 1972, we have grown our business into diversified markets and areas including but not limited to:

- Testing Instruments & solutions
- Sensors
- Manufacturing
- Services & Support



BOX COMPRESSION TESTERS

VARIOUS MODELS

Available in 3 capacities – 50kN, 50kN & 100kN, the Box Compression Tester is a floor-mounted machine where a complete pallet can be loaded into the machine. It is designed to evaluate packages and material under compressive loads. One platen is supplied with the machine measuring 1000mm x 800mm x 25mm which can be fixed or floated, as well as a base platen with the same dimensions. The software used is the IDM Instruments Pty Ltd® Universal Tester Software.



BOX OPENING PRESSURE TESTER

MODEL NO. B0013

This unit has been designed to measure the thickness of high loft nonwoven material, by means of a digital readout. Thickness is determined by observing the linear distance that a moveable plane is displaced from a parallel surface by the specimen while under a specified pressure.



PRECISION DROP TESTERS

VARIOUS MODELS

Available models include 150 kg capacity & 75 kg capacity, this instrument Performs vertical impact tests on complete, filled transport packages by dropping. The test may be performed either as a single test to investigate the vertical impact or as part of a sequence of tests designed to measure the ability of a package to withstand a distribution system that includes a vertical impact hazard. Optional fixtures can be supplied to conduct bucket drop, corner drop, and edge drop tests.



BURSTING STRENGTH TESTER

MODEL NO. BT-21C/P

The Bursting Strength Tester determines the bursting strength of paper, board and corrugated board. It features built-in software, operated through the touch panel screen. The software allows a choice of testing units, as well as complete statistics, and RS-232 for connection to an external computer



COBB MOISTURE ABSORPTION TEST RING & ROLLER

MODEL NO. C0005 & C0006

The Cobb Moisture Absorption Test Ring and Roller have been specifically designed to help determine the quantity of water absorbed by non-bibulous paper, paperboard and corrugated fibreboard. It is not suitable for tests on un-sized porous papers such as newsprint or blotting paper.



CARTON CREASE PROOFER

MODEL NO: C0053

This user-friendly instrument is commonly utilized in ink laboratories to assist the development of flexible coatings that resist cracking on commercial cartons. It allows the operator to quickly produce quality carton board crease samples without committing machine time. The unit comes complete with robust rules & dies which are of the same quality of those used with a full scale cut and crease machine.



CREASE & STIFFNESS TESTER

MODEL NO. C0039-M1

This unit has been designed to measure the thickness of high loft nonwoven material, by means of a digital readout. Thickness is determined by observing the linear distance that a moveable plane is displaced from a parallel surface by the specimen while under a specified pressure.



CREASE TESTER FOR ROUND CORNERS

MODEL NO. C0039-M2

The C0039-M2 is specifically designed to determine the crease recovery for cartons with rounded corners. The unit can be adjusted to also attach a 90° Crease fixture.



DIGITAL CREASE STIFFNESS TESTER

MODEL NO. C0039-M3

Along with the above-mentioned features of the C0039 M1 & M2 model, C0039-M3 includes a digital display. The real-time display screen is the latest addition to the Digital Stiffness Tester. The digital display is colour touch screen ensures simple operation making it convenient to check statistics, test reports and results. This product is the latest and most updated version available

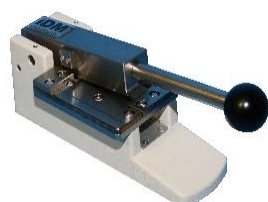

CREASE AND STIFFNESS CUTTER

MODEL NO. C0016

The Tetrapod Abrasion Tester tests the mechanical action on surface texture of textile carpet. A cylindrical drum, is rotated so that the tetrapod 'walks' over the specimens. The appearance of the tested specimen is compared to that of a concurrently tested controlled specimen.



COEFFICIENT OF FRICTION TESTER – MANUAL

MODEL NO. C0054

This user-friendly instrument is commonly utilized in ink laboratories to assist the development of flexible coatings that resist cracking on commercial cartons. It allows the operator to quickly produce quality carton board crease samples without committing machine time. The unit comes complete with robust rules & dies which are of the same quality of those used with a full scale cut and crease machine.



COEFFICIENT OF FRICTION TESTER - STANDARD

MODEL NO. C0055-M1

The standard C0055-M1 unit can measure Static COF (peak) from a resting position and continue to move testing surfaces in a relative motion to give an accurate kinetic COF (dynamic) result. This model features a stationary sled with a moving plane and also comes with the option of computer software to record data. Peel Testing can also be carried out on this unit.

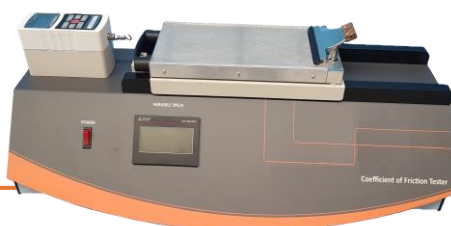

COEFFICIENT OF FRICTION TESTER – VARIABLE SPEED

MODEL NO. C0055-M2

The C0055-M2 comes with the addition of variable speed from 50 – 300mm/min using a stepper motor for accurate variable speed control. Controls are via an LCD touch screen for stop, start, home and speed changes. This model is the next level in accurate and precise COF measurement for static and kinetic results and comes with the option of computer software to record data. Peel Testing can also be carried out on this unit.



COF TESTER – VARIABLE SPEED & HEATED PLATEN

MODEL NO. C0055-M2

The Hydrostatic Head Tester is used to determine the resistance of textile fabrics to penetration by water at a constant rate of increase of pressure. The hydrostatic pressure supported by a fabric is a measure of the resistance to the passage of water through the fabric.



COEFFICIENT OF FRICTION TESTER – INCLINE PLANE

MODEL NO. C0045

This apparatus is used to determine the resistance of textile fabrics to penetration by water at a constant rate of increase of pressure. A manual version of the Hydrostatic Head Tester, the user operates the hand pump.

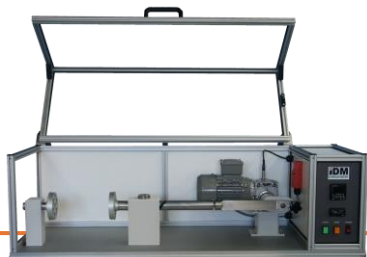

GELBO FLEX TESTER – PLASTIC

MODEL G0002

The Gelbo Flex Tester is used to determine whether certain laminations of plastic withstand repetitive strain. By attaching sample pieces of laminated plastic to the two circular clamping disks, via hose clamps, the specimen is twisted and turned to the specific movements. This process will show a visual result of pin holding and delamination.



FILM FREE SHRINK TESTER

MODEL NO. F0006

The Film Free Shrink Tester consists of a small, circular aluminium block, electrically heated and controlled by a temperature controller. Using aluminium foil discs with silicon oil, the test piece is placed into it to accelerate shrinkage at selectable temperatures.



HOT TACK TESTER

MODEL NO. H0005

An advanced system for monitoring the seal performance of flexible and semi rigid plastic bags or tubes. This unit determines the capability of a heat-seal joint to hang together when it is stressed, at a specified time interval, while still hot from the sealing operation, but before it reaches ambient temperature. The overall design of a package can contribute or detract from the materials ability to provide hot tack during the sealing process.



ECONOMIC HOT TACK TESTER

MODEL NO. GBR

Drying Ovens are available to suit a variety of heating and drying applications. Fan forced ovens feature digital temperature control, high capacity heating elements, heavy duty fan motors, adjustable exhaust vent, positive door latch and superior horizontal air flow system.



GURLEY AUTOMATIC DENSOMETER & SMOOTHNESS TESTER

MODEL NO. 4340

This unit measures the porosity, air-permeability or air resistance of sheet-like materials. It combines the abilities of a low, standard and high pressure tester with a digital timer that provides a reading in seconds.



CONCORA FLUTTER

MODEL NO. C0013

This machine is used to form test flutes in medium in preparation for crush tests. Temperature is maintained at a constant 175°C. One roller is motor driven at 4 r/min, while the other is free to rotate with a minimum of friction or other resistance. Variable speed option is available.



COATING THICKNESS GAUGE

MODEL NO.
CTG300

An efficient and clean method of measuring and applying a precise volume of ink to the Proofer unit. It is clearly marked with graduations of 0.1 ml enabling the operator to measure an accurate and repeatable volume of ink up to 1.0 ml in 0.05 ml increments.



INK RUB TESTERS (SUTHERLAND)

MODEL NO. I0001

Ink Rub Testers are designed to determine the quality of adhesion, and scuff resistance of ink to paper surfaces, plastic and aluminium film. The method of operation is that a 2 or 4 lb weight with a clean white board is swept across the test piece for a set number of times, and then closely examined. Heated weights are also available for these units.



COLOUR CHECK CABINETS

MODEL NO. C0048

Used for assessing colour changes under different light sources, to determine suitability of materials for industrial applications where there is the need to maintain colour consistency and quality. Fluorescent daylight, incandescent and optional black light may be used either individually or in combination.



INKOMETER - ELECTRONIC

MODEL NO. 1100

This machine measures the apparent tack of printing ink under conditions closely approximating the dynamic conditions of the ink-distribution system of a printing press. The testing instrument provides the highest accuracy and efficiency for research and development, quality control and process evaluation to verify, test and improve quality.



PAPER TUBE CRUSH TESTER

MODEL NO: C0020

This unit has been designed as a cost effective machine to measure the strength of manufactured paper cores up to a crushing force of 10kN. The crush test samples can be slices of the paper core ranging from 25mm to 100mm wide and up to 300mm in diameter.



PAPER SCHMIDT HAMMER

MODEL NO. 3421

An efficient and clean method of measuring and applying a precise volume of ink to the Proofer unit. It is clearly marked with graduations of 0.1 ml enabling the operator to measure an accurate and repeatable volume of ink up to 1.0 ml in 0.05 ml increments.



PERMEABILITY CUP - VAPOMETERS

VARIOUS MODELS

Crush Testers determine the compression strength of corrugated and fibreboard and their components. Operation is completed by built-in software through an easy to use backlit alphanumeric keypad. Optional accessories are available for Flat Crush, Edge Crush, Short Column, Pin Adhesion, Ring Crush, Corrugated Crush-Cross Direction etc.



PET BOTTLE PRESSURE TESTER

MODEL NO. PEBT-4000

The PEBT-4000 PET Bottle Pressure Tester is an advance testing equipment specialized for testing the PET bottles. It has been designed in conformity to the three international commonly used testing methods: (1) Ramp Fill Mode; (2) Burst Mode; (3) User-Defined Mode. The machine uses touch screen interface with automatic effusion, clamping the sample and testing.



PACKAGE SHAKER VIBRIMAX

MODEL NO. UMX

Package Shakers are designed for laboratory simulation of typical hazards present in the distribution environment. Featuring adjustable vibration frequency of 25Hz (120-300rpm).



BOX CALIPERS

MODEL NO. C-INT

Box Calipers are used by manufacturers and end users to control quickly and precisely the internal dimensions of packages. This is fundamental to the preservations of the goods wrapped during transportation, storage and handling; thus reducing the risk of possible future losses caused by products out of specification.



CREASE BEND TESTER

MODEL NO. B0012

An efficient and clean method of measuring and applying a precise volume of ink to the Proofer unit. It is clearly marked with graduations of 0.1 ml enabling the operator to measure an accurate and repeatable volume of ink up to 1.0 ml in 0.05 ml increments.



CRUSH TESTER

MODEL NO. CT-21

Crush Testers determine the compression strength of corrugated and fibreboard and their components. Operation is completed by built-in software through an easy to use backlit alphanumeric keypad. Optional accessories are available for Flat Crush, Edge Crush, Short Column, Pin Adhesion, Ring Crush, Corrugated Crush-Cross Direction etc.



FLAT CRUSH TESTER CUTTER & FIXTURE

MODEL NO. C0032
& F0011

Evaluates the resistance of flutes in corrugated board to a crushing force applied perpendicular to the surface of the board. The Flat Crush Test requires the use of the F0011 fixture to prevent lateral movement of the upper portion of the test piece during compressions and also the use of the Cutter which can cut through the corrugated structure, leaving clean cut edges at right angles to the faces.



RING CRUSH TEST FIXTURE

MODEL NO. R0008

Designed to carry out the ring crush test for paper and board having an average thickness of up to 1000µm, for the purpose of MD ring crush, CD ring crush, liner or fair side. The test piece of paper or board is supported in the ring crush holder and subjected to edgewise compression between the platens of a crush testing machine.



SCORE BEND TESTERS

VARIOUS MODELS

IDM offers machines to measure the force to open or bend paperboard and scored paper carton. Optional fixtures can be fitted to also conduct spring back after folding, providing critical information for sealing or gluing operations.



SCOTT INTERNAL BOND TESTER

MODEL NO.
PCA1270

This instrument is used to produce a high speed Z-directional rupture of paper and paperboard. It is a dynamic test that measures and defines strength in terms of energy absorption.



TENSILE TESTER – MANUAL

MODEL Z SPAN

Crush Testers determine the compression strength of corrugated and fibreboard and their components. Operation is completed by built-in software through an easy to use backlit alphanumeric keypad. Optional accessories are available for Flat Crush, Edge Crush, Short Column, Pin Adhesion, Ring Crush, Corrugated Crush-Cross Direction etc.



TENSILE TESTER – AUTOMATIC

MODEL NO. PEBT-
4000

The Automated Z-Span™ Tester can automatically update a local PC-based Excel data-base. The Automated Z-Span Tester is calibrated and control software is loaded as part of in-factory system integration.



THICKNESS GAUGES - ULTRASONIC

MODEL NO. T2100
SERIES

Thickness of the measured material is based on the accurate time that the ultrasonic transmits in the material. This Gauge series are equipped with microcomputers that analyze, handle and display the current data. They feature highly optimized measuring circuits and offer high measurement accuracy.



HALL EFFECT THICKNESS GAUGE

MODEL MBT-300

Featuring a large display screen, this instrument is designed to measure the thickness of non-magnetic material up to 25.4mm thick (glass & plastic bottles, aluminum cans etc.)



BOTTLE WALL THICKNESS GAUGE

MODEL NO. BWTF-200

The Contact Angle tester is designed to check surfaces properties for contamination, adhesion and printability of various materials. It measures the dynamic contact angle as wetting, absorption and spreading over time. With an integrated camera which captures 80 images per second, this user-friendly unit runs via USB connection to a PC.



LIGHT TRANSMISSION & HAZE TESTERS

MODEL NO. SGW-810

To test the light transmittance and haze degree of all transparent and semi-transparent parallel plane samples (plastic plate, sheets etc), and turbidity or clarity of liquid samples (water, drinks etc), used in the industries of plastics, membrane, coatings and paints, printing ink etc..



LIGHT TRANSMISSION TESTER

MODEL NO. L0005

The Light Transmission Tester has been specially designed and manufactured to evaluate the light transmission properties of various shaped plastic containers.



GLOSS & HAZE METERS

MODEL QUICKPEEK

A range of Gloss Meters are available to determine the specular reflection of various materials. Gloss Meters can measure in 20°, 60° or 80°, all in the one single unit, with results displayed instantly, including the difference, pass/fail and statistics on display.

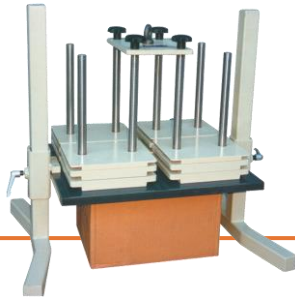

DEAD WEIGHT COMPRESSION TESTER

MODEL D0003

Designed to perform either as a single test to investigate the effect of deformation, creep, collapse or failure as part of a sequence of tests designed to measure the ability of a package, to withstand a distribution system that includes a compression hazard. It may also be used to investigate performance under particular conditions of loading.



DESNOMETER

MODEL NO. PAG-100

The air permeance is the flow of air through unit area under unit pressure difference in unit time, under specified test conditions and is expressed in $\mu\text{m}/\text{Pa}\cdot\text{s}$. This equipment is used to measure the thickness of paper, plastic, tissue and other sheeted material and features a built-in computer and exclusive testing software.



DIGITAL MICROMETERS

MODEL NO. D0011

This range of instruments is used to measure the thickness of paper, plastic, tissue and other sheeted material, these units automatically cycle up and down, providing an accurate and repeatable thickness reading at the end of each cycle.



DRYING OVENS

VARIOUS MODELS

Drying Ovens are available to suit a variety of heating and drying applications. Fan forced ovens feature digital temperature control, high capacity heating elements, heavy duty fan motors, adjustable exhaust vent, positive door latch and superior horizontal air flow system.

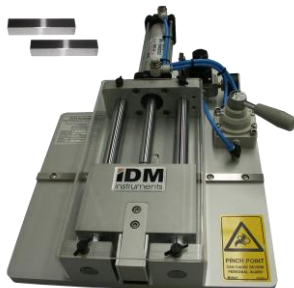

EDGE COMPRESSION CUTTER & GUIDE BLOCKS

MODEL E0001 & E0002

The Quickpeek Color Proofing Kit is used to quickly produce a proof that replicates how ink will appear on a printed copy from the press. Different rollers can be used for heat set inks or UV inks.



COLOUR COMPARATIVE SYSTEM

MODEL
COLORSTRIKER

The ColorStriker is user-friendly and can be used in various industries to test almost any material or surface type, including textiles, leather, paint, varnishes, wood, tiles, plastics and more. Users can easily create and manage a custom colour archive. With the integrated texture library, the desired colour effect can be checked on screen for a wide variety of applications (ie. Wood chips, textile materials, leather etc).



COLOUR ANALYZER

MODEL NO. RBG-
1002

The Constant Deflection Static Force instrument determines the loss of indentation force deflection (IFD), loss of thickness and the structural breakdown by visual assessment of polyurethane.



PAGE PULL TESTERS

MODEL NO. P0011

The Page Pull Tester has been designed and manufactured to measure the strength required to pull pages out of bound books and magazines. The force is displayed on the digital read out, ensuring a quality bound book is provided to customers.

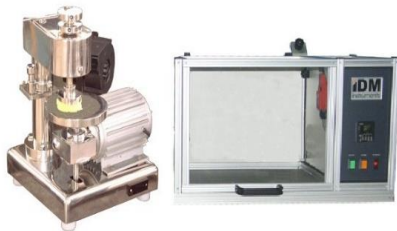

RUB PROOF TESTER

MODEL NO. 10005

The Rub Proof Tester is used to evaluate the ink transfer from printed / coated materials from rubbing. 3 x dead loads are included to place one on top of the upper disc to achieve a known pressure.

The sample holders are manufactured from stainless steel to enable dry or wet rubs and a digital cycle counter stops the test at the pre-set value.



COLOUR PROOFING KIT

MODEL QUICKPEEK

The Quickpeek Color Proofing Kit is used to quickly produce a proof that replicates how ink will appear on a printed copy from the press. Different rollers can be used for heat set inks or UV inks.



ISO BRIGHTNESS

VARIOUS MODELS

IDM offer a range of economical and easy to use brightness testers which provide instantaneous digital read outs of TAPPI/GE brightness, with the option of measuring with and without the excitation of fluorescent agents.

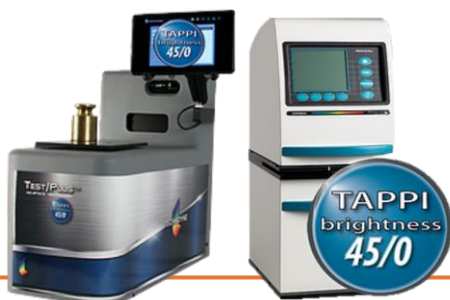

PROFILE/PLUS™ TAPPI BRIGHTNESS

VARIOUS MODELS

The PROFILE/Plus TAPPI Brightness measures optical properties according to industry standards including colour, opacity, fluorescence, TAPPI Brightness and colour difference.

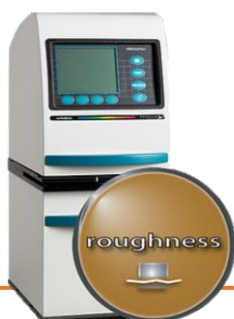

PROFILE/PLUS™ ROUGHNESS & POROSITY

VARIOUS MODELS

The Technidyne PROFILE/Plus Roughness and Porosity measures surface roughness and air permeance according to industry standard methods. Includes two sided measurements, selectable reporting units, dry diaphragm air compressor, NIST traceable laminar flow elements, barometric pressure and temperature compensation.



TEST/PLUS™ GLOSS

VARIOUS MODELS

This instrument combines industry standardized measurement technology with an innovative control package that allows the user to tailor build their testing and evaluation capabilities. Built on the Android software platform, the interface can be customized with the features important to you. Available in 75- and 20-degree angles.



PROFILE/PLUS™ TENSILE

VARIOUS MODELS

With a precise punch and die assembly to ensure constant sample size, this unit automatically performs sample clamping, measurements of MD and CD tensile strength, elongation, and TEA all on its own.

User defined measurement parameters means that grade specific reporting units can be selected.



LABORATORY HEAT SEALERS

MODEL NO. L0001-
PRO & PRO-S

Laboratory Heat Sealers are designed to be used for development work to help determine the sealing properties and characteristics of plastic and laminated materials. The Heat Sealer is electrically heated and temperature controlled with adjustable sealing pressure, controlled by a timer.



LAMINATOR

VARIOUS MODELS

The Pulmac Laminator is a robust laminator designed to be used with the Pulmac MasterScreen for sample preparation of displays for analysis of Stickies, Dirt, and/ or Shives by scanner. This laminator is designed for industrial use. Temperature, nip pressure, and roller speed have been standardized. The unit comes with a carrier.



MOISTURE BALANCES

MB SERIES

The MB Series Moisture Balance offer superior performance and great value, with basic as well as advanced models available. It features fast halogen element which provides uniform infrared heating and durability.



MOISTURE METERS

VARIOUS MODELS

Universal moisture meters determine the moisture content in paper, cardboards, wood, building materials, isolation and other materials. A range of moisture meters are available to suit applications and budgets.



QUICK CUT

MODEL NO. C0046

An easy to operate apparatus used for cutting corrugated cardboard for sample preparation. The base is supplied with engraved cutting guides for quick and easy cutting of cardboard.



CIRCULAR HAND CUTTERS

MODEL NO. C0038

The Circular Hand Cutters are fast and easy to operate, creating accurate circular samples in various different mediums. They are available in several different sizes (including custom sizes) for suitability to many different tests.



CUTTING TEMPLATES - STAINLESS

MODEL NO. C0034

Manufactured from stainless steel with an easy to grip handle to provide a consistent cut out shape for example; Coefficient of friction testers, Colour fastness tester, etc.

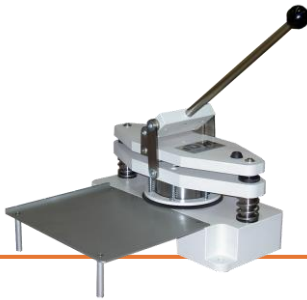

GRAMMAGE CUTTER

MODEL NO. C0042

Designed to cut 100cm² circular paper samples to assess Grammage. This is an important factor as most paper is bought and sold in accordance with its mass per unit area. Other values such as bursting strength, thickness and bulk are all determined using Grammage.



GUILLOTINES

VARIOUS MODELS

IDM supply a range of Guillotines to suit various applications. Bench top and free standing units are available.



ELMENDORF TEAR TESTER

MODEL PROTEAR

The ProTear Tester quickly and accurately measures the tear resistance of sheet materials including paper, textiles, roofing products, film and foils. Three models are available, Electronic ProTear, Mechanical ProTear and the Heavy-Duty ProTear.



WATER RESISTANCE OF GLUE BOND TESTER

MODEL NO. RC-21

Specifically designed to determine the resistance of corrugated paperboard to withstand wet conditions by immersion in water.



WATER VAPOR PERMEATION ANALYZER GRAVIMETRIC

MODEL NO. W300

With the Gravimetric Method, these units test the water vapour transmission rate (WVTR) of packaging materials, such as plastic film, composite film, co-extrusion film, aluminium-plated film, aluminium foil, infusion bag, sheets, paper, paper board, solar battery panel, cellophane, ceramics and porcelain, and various containers such as bag, pouch, bottle, can, bowl, box, widely used in the industries of food, pharmaceuticals etc.



WATER VAPOR PERMEATION ANALYZER INFRARED

MODEL NO. W402

With the Infrared Detection Sensor Method, this unit tests the water vapor transmission rate of various materials, including: plastic film, composite film, aluminum-plated film, aluminum foil etc.; packaging containers, such as bag, bottle, bowl, can etc.; sheets, such as PP sheet, PVC sheet, rubber, building material, porcelain; other application, such as solar panel, paint film, medical patch etc.



WATER VAPOUR TRANSMISSION TESTER

MODEL NO. PVA/4

Used for the preparation of test pieces for the accurate measurement of the water vapour transmission rate flexible packaging materials, including parchment, wax paper, polyethylene, vinyl, cellophane, foil, laminates, and other materials.

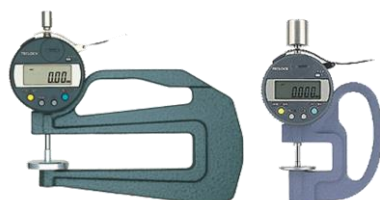

THICKNESS GAUGES - HAND HELD

MODEL NO. T0014

Handheld Thickness Gauges can be used on many different materials where an accurate measurement of thickness is required. Different models are available depending on weight and contact point required.



UNIVERSAL TESTING MACHINES

VARIOUS OPTIONS

IDM provides a range of UTM's which feature multiple testing capabilities including compression testing and tensile testing. UTM's eliminate the need of having multiple machines to perform various tests (i.e. compression and tensile). UTM's offer versatility and the ability to set up dual tests to speed up test set up, production & ultimately reduces operator fatigue & possible setup errors.

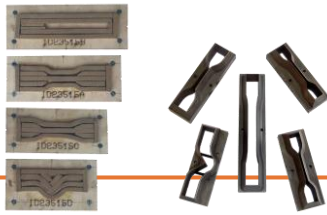

CUTTING DIES

VARIOUS OPTIONS

Tool Steel and Ruler Dies of standard and custom sizes can be used and interchanged with ease, allowing a large range of dies to be used with any press. These dies are manufactured as per samples sizes mentioned in various testing standards.



SAMPLE CUTTING PRESSES

VARIOUS OPTIONS

IDM offers a range of sample cutting presses which are fast and easy to operate. Used for sample preparation of various sized test pieces. The cutting dies are manual, hydraulic, pneumatic. Available in various capacities to suit all sample preparation requirements.



THICKNESS GAUGE DIGITAL INDICATOR WITH STAND

MODEL NO. T0013

This unit has been designed to measure the thickness of high loft nonwoven material, by means of a digital readout. Thickness is determined by observing the linear distance that a moveable plane is displaced from a parallel surface by the specimen while under a specified pressure. Thickness is one of the basic physical properties of High loft Nonwoven fabrics. In certain industrial applications, the thickness may require rigid control within specified limits.

QUALITY EXCELLENCE ASSURED

The IDM Preventive Maintenance and Calibration (PM&C) program has been designed to make the maintenance and calibration of your valuable testing equipment more cost effective by preventing breakdowns and downtime by regular calibration, service and replacement of defective parts.

We have successfully executed this program with the help of 38+ representatives spread across the globe. PM&C team members are supplied with the necessary resources to main our testing equipment at peak performance throughout thier lifetime, benefiting both you and your equipment. Testing equipment in your facility (or at IDM) will be calibrated using industry-wide, internationally recognised standards or as per your specific requirements.

Calibrated instruments are labelled accordingly and documented with an IDM full calibration report or certificate of conformance (whichever is applicable). All calibrations are maintained in IDM's calibration database and you will be notified when your next service/calibration is due. IDM's Calibration work is comprehensive- adjusting your equipment to give you the right results, whenever possible.

For over 49 years now, the IDM name and brand has grown across the globe. Our commitment to quality and providing the measurable difference reflects upon our customers' satisfaction. We look forward to continuing to provide our expertise and assisting you with your next requirement. Speak to IDM today, and see how an IDM testing instrument will benefit your quality control process.

INDUSTRIES & APPLICATIONS



Printing



Textiles



Paper



Rubber



Plastic



Packaging



Foam & Mattress



Research & Laboratory

& many more....

TESTING INSTRUMENTS FOR
A MEASURABLE DIFFERENCE...

IDM
instruments



TESTING INSTRUMENTS | SENSORS | MANUFACTURING | SERVICE & SUPPORT

IDM INSTRUMENTS PTY LTD
10 - 11 Colrado Court
Hallam, Victoria 3803 Australia
Tel: +61 3 9708 6885
E: sales@idminstruments.com.au
www.idminstruments.com.au