



Series 3 digital force gauges are designed for tension and compression force testing in numerous applications from 0.12 lbf to 500 lbf (0.5 N to 2500 N). The gauges feature a sampling rate of 2,000 Hz, producing accurate results under a wide range of test conditions. A backlit graphic LCD displays large characters, and a menu is available to access the gauges' features and configurable parameters. USB output is provided for data collection purposes.

Set point indicators are provided for pass-fail testing. The gauges are overload protected to 200% of capacity, and an analog load bar is shown on the display for graphical representation of applied force.

An ergonomic, reversible aluminum housing allows for hand held use or test stand mounting for more sophisticated testing requirements. Series 3 digital force gauges are directly compatible with Mark-10 test stands, grips, and software.



Shown with an ES20 test stand and G1061 wedge grips

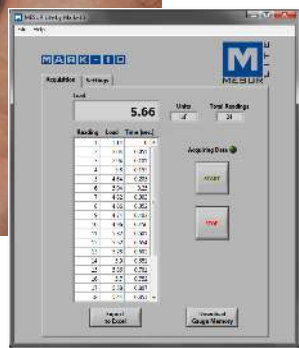

MESUR Lite data acquisition software is included with Series 3 gauges

Series 3 gauges include MESUR™ Lite data acquisition software, for tabulation of continuous or individual data points. One-click export to Excel button easily allows for further data manipulation.

Features

- High-speed 2,000 Hz sampling rate
- USB data output of continuous or individual data points
- Ultra-compact size
- Large backlit graphic display
- Programmable set points with pass/fail indicators
- Live load bar graph with set point markers
- Peak readings and set points always displayed
- Configurable audio alarms and key tones
- 4 selectable units of measurement
- MESUR™ Lite data collection software included

Display Indicators



Focus on Engineering: Reversible Housing



Specifications

Accuracy:	±0.3% of full scale ±1 digit
Sampling Rate:	2,000 Hz
Power:	AC or rechargeable battery. Multi-step low battery indicator is displayed, gauge shuts off automatically when power is too low.
Battery life:	Backlight on / off: up to 7 / 24 hours of continuous use
USB Output:	Configurable to 115,200 baud.
Safe overload:	200% of full scale (display shows "OVER" at 110% and above)
Weight (gauge only):	M3-012 - M3-100: 0.7 lb [0.33 kg] M3-200 - M3-500: 0.9 lb [0.41 kg]
Load cell deflection:	All models 0.010 [0.25], except 0.005 [0.13] for M3-012
Included items:	Carrying case with chisel, cone, V-groove, hook, flat, extension rod, universal voltage AC adapter, battery, quick-start guide, USB cable, resource CD (USB driver, MESUR™ Lite software, MESUR™ gauge DEMO software, user's guide), NIST-traceable certificate of calibration (certificate with data is available for an additional charge).
Environmental requirements:	40 - 100°F, max. 96% humidity, non-condensating
Warranty:	3 years (see individual statement for further details)

Dimensions in [mm]

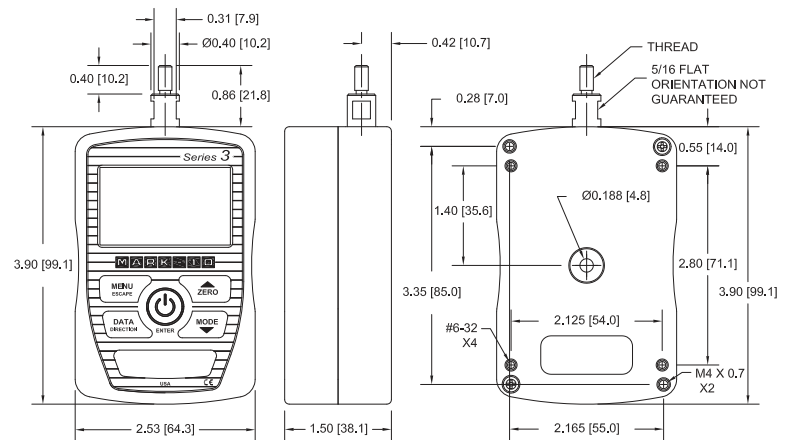

	Thread
M3-012 - M3-100	#10-32 UNF
M3-200 - M3-500	5/16-18 UNC

Capacity & Resolution

Model	lbF	kgF	gF	N
M3-012	0.12 x 0.0001	-	50 x 0.05	0.5 x 0.0005
M3-025	0.25 x 0.0002	-	100 x 0.1	1 x 0.001
M3-05	0.5 x 0.0005	-	250 x 0.2	2.5 x 0.002
M3-2	2 x 0.002	1 x 0.001	-	10 x 0.01
M3-5	5 x 0.005	2.5 x 0.002	-	25 x 0.02
M3-10	10 x 0.01	5 x 0.005	-	50 x 0.05
M3-20	20 x 0.02	10 x 0.01	-	100 x 0.1
M3-50	50 x 0.05	25 x 0.02	-	250 x 0.2
M3-100	100 x 0.1	50 x 0.05	-	500 x 0.5
M3-200	200 x 0.2	100 x 0.1	-	1000 x 1
M3-500	500 x 0.5	250 x 0.2	-	2500 x 2

Certificate of calibration with data is available. Part no. is: CERT.

All models include 110V AC adapters, unless ordered as below:

Add suffix 'E' for euro plug (220V), 'U' for UK plug (220V) or 'A' for Australian plug (220V).

Example: M3-05E, M3-100U, M3-500A