

# Inclinometer

## Precision Potentiometric Output Ranges: 0-105° to 0-240° Industrial Grade



# IT9101

### Specification Summary:

#### GENERAL

Available Full Stroke Ranges ..... 0-105 to 0-240 degrees  
 Enclosure Material Options ..... powder-painted aluminum or stainless steel  
 Sensor ..... plastic-hybrid precision potentiometer  
 Electrical Connector ..... MS3102E-14S-6P  
 Mating Plug (included) ..... MS3106E-14S-6S  
 Weight, Aluminum (Stainless Steel) Enclosure ..... 5 lbs. (10 lbs.) max.

#### ELECTRICAL

Output Signal ..... voltage divider (potentiometer)  
 Input Resistance ..... 1000 Ω (±10%)  
 Recommended Maximum Input Voltage ..... 30 V (AC/DC)  
 Output Signal Change Over Measurement Range ..... 92% ± 6% of input voltage

#### PERFORMANCE

Accuracy\* ..... ± 1% full stroke  
 Accuracy Option ..... ± 0.5% full stroke—please contact factory  
 Resolution ..... essentially infinite  
 \*—when plane of pendulum motion parallel to plane of rotation within ± 3°

#### ENVIRONMENTAL

Enclosure ..... NEMA 4/4X/6, IP 67/68  
 Operating Temperature ..... -30° to 200°F (-34° to 90°C)  
 Vibration ..... up to 10 G's to 2000 Hz maximum



The model IT9101 is a rugged and simple device which provides a voltage divider feedback signal for incline position. The heart of the IT9101 is a magnetically-damped pendulum coupled to a conductive plastic precision potentiometer.

A highly linear relationship between inclination and the output signal is maintained over the full range of the IT9101.

### Outline Drawing

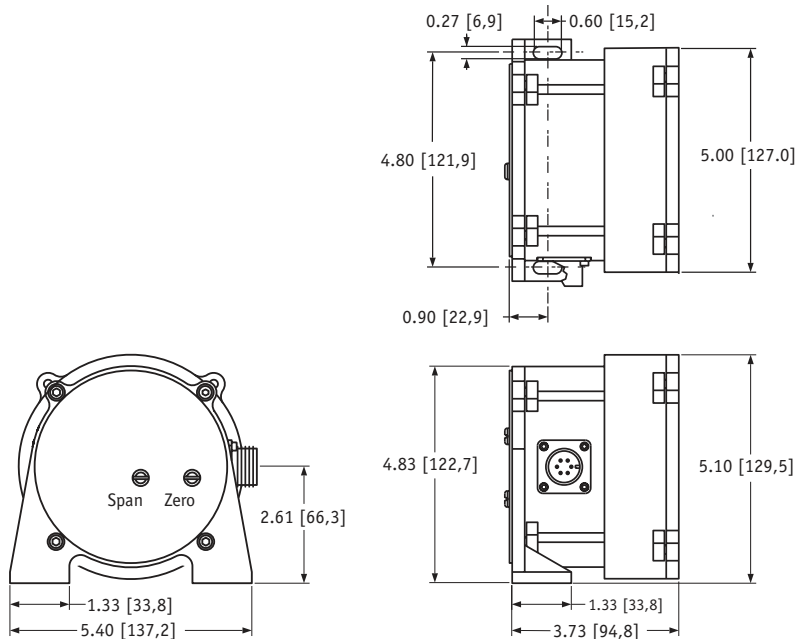

### Output Signal

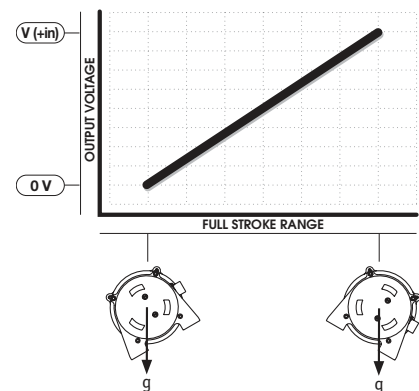

**Ordering Information:**

**Model Number:**

IT9101 -          CW -          CCW -      A      B      C      D

Sample Model Number:  
IT9101 - 060 - 120 - 1110

- CW clockwise rotation: 60°
  - CCW counter-clockwise rotation: 120°
  - A enclosure: aluminum
  - C electrical connection: 6-pin plastic connector
  - D magnetic damping: yes
- } total rotation = 180°

**Full Clockwise Rotation:**

CW	order code:	000	015	030	045	060	075	090	105	120
		0°	15°	30°	45°	60°	75°	90°	105°	120°

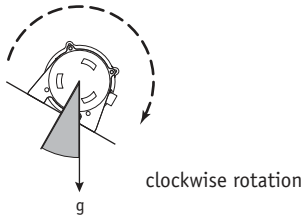

**Important--**  
the sum of the Clockwise and Counter-Clockwise Rotations must be in the range of 105° to 240°

**Full Counter-Clockwise Rotation:**

CCW	order code:	000	015	030	045	060	075	090	105	120
		0°	15°	30°	45°	60°	75°	90°	105°	120°

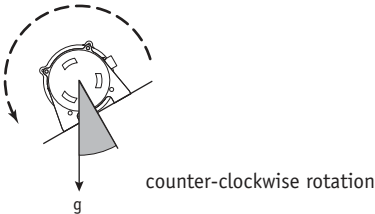

**Important--**  
the sum of the Clockwise and Counter-Clockwise Rotations must be in the range of 105° to 240°

**Enclosure Material:**

A	order code:	1	2
		powder-painted aluminum	303 stainless steel

**Electrical Connection:**

④ order code:

**1**  
6-pin plastic connector  
w/mating plug

IP 67, NEMA 4X\*\*, 6

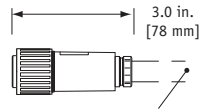

1/2 - 5/16" [14 - 8 mm] cable dia.  
16 AWG max conductor size  
connector: MS3102E-14S-6P  
mating plug: MS3106E-14S-6S

**2**  
10-ft. [3 M]  
waterproof cable

IP 67, NEMA 4X\*\*, 6

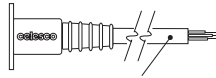

10 ft. x 0.4-in. dia.  
[3 M x 10 mm dia.]  
18 AWG, type SJTW

**4**  
25-ft. [7.5 M]  
instrumentation cable

IP 67, NEMA 6



25 ft. x 0.2-in. dia.  
[7,5 M x 5 mm dia.]  
24 AWG, shielded

④ order code:

**5**  
100-ft. [30 M]  
waterproof cable

IP 67, NEMA 4X\*\*, 6

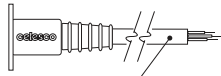

100 ft. x 0.4-in. dia.  
[30 M x 10 mm dia.]  
18 AWG, type SJTW

**6**  
10-ft. [3 M]  
**pressure tested\***  
waterproof cable

IP 68, NEMA 4X\*\*, 6P

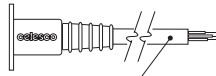

10 ft. x 0.4-in. dia.  
[3 M x 10 mm dia.]  
18 AWG, type SJTW

**7**  
100-ft. [30 M]  
**pressure tested\***  
waterproof cable

IP 68, NEMA 4X\*\*, 6P

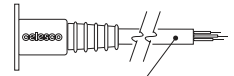

100 ft. x 0.4-in. dia.  
[30 M x 10 mm dia.]  
18 AWG, type SJTW

**6-pin Mating Plug**

pin	signal
A	+ in
B	common
C	+ out
D	-

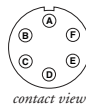

**Waterproof Cable**

color code	signal
WHITE	+ in
BLACK	common
GREEN	+ out

**Instrumentation Cable**

color code	signal
RED	+ in
BLACK	common
GREEN	+ out
WHITE	-

\*-Test pressure: 100 feet [30 meters] H<sub>2</sub>O (40 PSID) Test Medium: Air; Duration: 2 hours. \*\*-applies to stainless steel enclosure only.

**Dampening Option:**

① order code:

**0**  
with magnetic dampening

**1**  
without magnetic dampening

# Inclinometer

## RS232 Data Communication

Ranges: 0-105° to 0-240°

Industrial Grade



# IT9232

### Specification Summary:

#### GENERAL

Full Stroke Ranges..... 0-105 to 0-240 degrees  
 Electrical Interface..... RS232  
 Format..... HEX  
 Accuracy\*..... ± 1% full stroke  
 Accuracy option..... ± 0.5 % full stroke—please consult factory  
 Resolution..... ± 0.003% full stroke  
 Enclosure Material..... powder-painted aluminum or stainless steel  
 Sensor..... plastic-hybrid precision potentiometer  
 Weight, Aluminum (Stainless Steel) Enclosure..... 5 lbs. (10 lbs.), max.  
 \*—when plane of pendulum motion parallel to plane of rotation within ± 3°

#### ELECTRICAL

Input Voltage..... 9...22 VDC  
 Input Current..... 40 mA, max.  
 Baud Rate..... 9600 (programmable to 38.4K)  
 Update Rate..... 32 msec

#### ENVIRONMENTAL

Environmental Suitability..... NEMA 4X/6, IP 67  
 Operating Temperature..... 32° to 176°F (0° to 80°C)  
 Vibration..... up to 10 G's to 2000 Hz maximum



The IT9232 delivers incline position feedback via RS232 serial communication to your data acquisition or controller system. The heart of this inclinometer is a magnetically-damped pendulum coupled to a conductive plastic precision potentiometer.

The IT9232 sends real time data that can be configured to produce engineering units or a raw 16-bit count from 0000H to FFFFH. Additionally this device can be set to continuously send data or send data only when polled.

### Outline Drawing

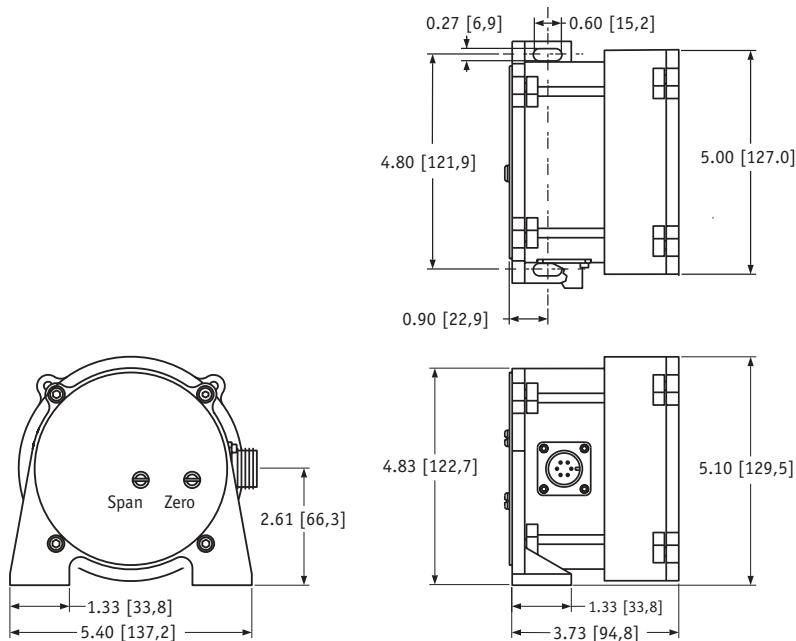

### Output Signal

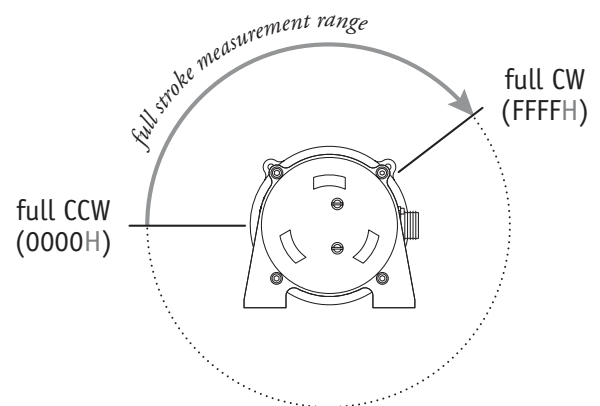

Celeco Transducer Products, Inc.  
 20630 Plummer Street • Chatsworth, CA 91311  
 tel: 800.423.5483 • +1.818.701.2750 • fax: +1.818.701.2799

**celeco**  
 celeco.com • info@celeco.com

**I/O Format:**

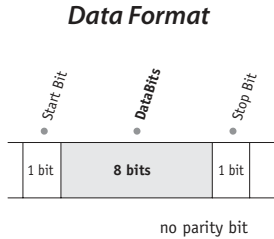

**Data Frame**

6 byte Hex string:

STX	CMD	B <sub>0</sub>	B <sub>1</sub>	B <sub>2</sub>	ETX	
STX = 0x02	CMD = Command Code*	B <sub>0</sub> - B <sub>2</sub> = Data Field*			ETX = 0x03	

\*—see below

**Important!** All communications to/from the transducer are in **HEX!**

**User Commands:**

Description	User Command				Sensor Response			
	<CMD>	<B <sub>0</sub> >	<B <sub>1</sub> >	<B <sub>2</sub> >	<CMD>	<B <sub>0</sub> >	<B <sub>1</sub> >	<B <sub>2</sub> >
Get Sensor Info	0x05	0x00	0x00	0x00	0x05	version <sup>(4)</sup>	date <sup>(5)</sup>	date <sup>(5)</sup>
Get Serial Number	0x15	0x00	0x00	0x00	0x15	serial number <sup>(3)</sup>		
Start Continuous Data	0x25	0x00	0x00	0x00	0x25	0x00	0x00	0x00
Stop Continuous Data	0x35	0x00	0x00	0x00	0x35	0x00	0x00	0x00
Get Position Data	0x45	0x00	0x00	0x00	0x45	CMC <sup>(1)</sup>	CMC <sup>(1)</sup>	status <sup>(2)</sup>

**(1) CMC - Current Measurement Count (Position)**

The **Current Measurement Count (CMC)** is the output data that indicates the present position of the measuring cable.

The CMC is a 16-bit value that occupies the first two bytes (B<sub>0</sub> and B<sub>1</sub>) of the data field. B<sub>0</sub> is the MSB (most significant byte) and B<sub>1</sub> is the LSB (least significant byte).

The CMC starts at 0000H with the inclinometer in the full clockwise (**CW**) position and continues counter clockwise to the full counter-clockwise (**CCW**) position stopping at FFFFH. This holds true for all ranges.

**(2) Status**

The status byte is used as a flag to indicate the validity of the position signal that the internal electronics receives from the potentiometer.

Flags are as follows:  
0x00 = GREEN, 0x55 = YELLOW, 0xAA = RED

A “green” flag shows everything OK. A “yellow” or “red” flag indicates that the sensor has either been extended beyond its range or that there is a problem with the potentiometer.

**(3) Serial Number**

Each sensor has its own unique serial number. This information can be retrieved by sending the sensor the “Get Serial Number” command.

The serial number is a 3 byte value from which ranges from 0 to 9999999 (decimal).

**(4) Version**

This is a single byte value (0-255 decimal) which indicates the currently installed firmware version of the sensor.

**(5) Date**

This is a 2 byte value showing the date of currently installed firmware. This value ranges from 01011 - 12319 (decimal). Format is MMDDY. While the month and day are expressed as two digit numbers the year is expressed in a single digit only.

Example: 08054 = August 5, 2004

**Baud Rate**

The baud rate can be set using switches **7 & 8** on the 8-pole DIP switch found on the rs232 controller board located inside the transducer.

DIP-7	DIP-8	baud rate
0	0	9600
1	0	19200
0	1	38400
1	1	9600



**RS232 Controller Board and DIP Switch Location**

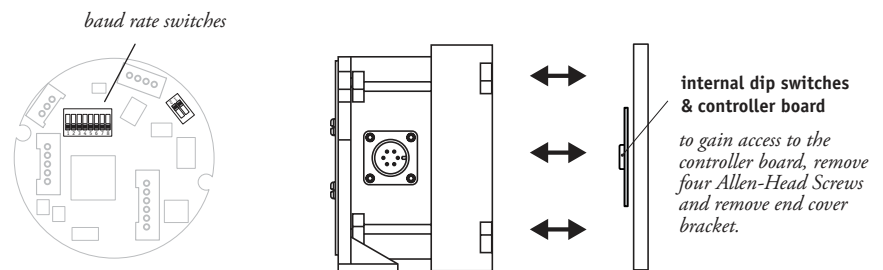

**Ordering Information:**

**Model Number:**

**IT9232** - \_\_\_\_\_ - \_\_\_\_\_ - \_\_\_\_\_  
 order code:                      **CW**                      **CCW**                      **A**                      **B**                      **C**

Sample Model Number:

**IT9232 - 60 - 120 - AL - D - M6**

**CW** clockwise rotation: 60°  
**CCW** counter-clockwise rotation: 120° } total rotation = 180°  
**A** enclosure aluminum  
**B** magnetic dampening: yes  
**C** electrical connection: 6-pin plastic connector

**Full Clockwise Rotation:**

<b>CW</b> order code:	<b>0</b>	<b>15</b>	<b>30</b>	<b>45</b>	<b>60</b>	<b>75</b>	<b>90</b>	<b>105</b>	<b>120</b>
	0°	15°	30°	45°	60°	75°	90°	105°	120°

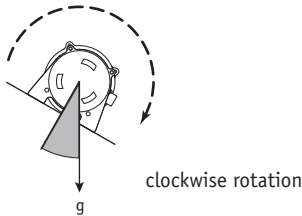

**Important--**  
 the sum of the Clockwise and Counter-Clockwise Rotations must be in the range of 105° to 240°

**Full Counter-Clockwise Rotation:**

<b>CCW</b> order code:	<b>0</b>	<b>15</b>	<b>30</b>	<b>45</b>	<b>60</b>	<b>75</b>	<b>90</b>	<b>105</b>	<b>120</b>
	0°	15°	30°	45°	60°	75°	90°	105°	120°

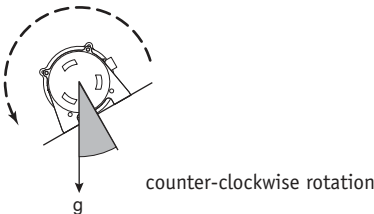

**Important--**  
 the sum of the Clockwise and Counter-Clockwise Rotations must be in the range of 105° to 240°

**Enclosure Material:**

<b>A</b> order code:	<b>AL</b>	<b>SS</b>
	powder-painted aluminum	303 stainless steel

**Dampening Option:**

<b>B</b> order code:	<b>D</b>	<b>ND</b>
	magnetic dampening	without magnetic dampening

**Ordering Information:**

**Electrical Connection:**

Ⓢ *order code:*

**M6**

6-pin plastic connector with mating plug

**IP 67, NEMA 6**

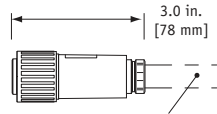

1/2 - 5/16" [14 - 8 mm] cable dia.  
16 AWG max conductor size



*contact view*

pin	
A	9...22 VDC
B	common
C	-
D	Transmitted Data
E	Received Data
F	common

**C25**

25-ft. instrumentation cable 24 AWG, shielded

**IP 67, NEMA 6**

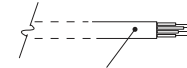

25 ft. x 0.2-in. dia.  
[7,5 M x 5 mm dia.]  
24 AWG, shielded

color code	
Red	9...22 VDC
Black	common
White	-
Green	Transmitted Data
Blue	Received Data
Brown	common

# Inclinometer

4...20 mA Output • Hazardous Area Certification

Ranges: 0-45° to 0-240°

Industrial Grade



# IT9420

## Specification Summary:

**GENERAL**  
 Available Full Stroke Ranges ..... 0-45 to 0-240 degrees  
 Weight (aluminum enclosure)..... 5 lb. typical (aluminum enclosure)  
 Enclosure Material.....aluminum (stainless steel available)  
 Sensor ..... precision potentiometer  
 Electrical Connector..... MS3102E-14S-6P  
 Mating Plug (included) ..... MS3106E-14S-6S

**ELECTRICAL**  
 Output Signal ..... 4...20 mA  
 Input Voltage ..... see ordering information  
 Input Current..... 20 mA max.  
 Circuit Protection.....38 mA maximum

**PERFORMANCE**  
 Sensitivity.....16 mA/full stroke, ± 0.25%  
 Accuracy\*..... ± 1% full stroke  
 Accuracy Option ..... 0.5% full stroke—*please contact factory*  
 Resolution .....essentially infinite  
 Output Signal Adjustment for Full Stroke Ranges of 45° - 105°:  
 Zero Adjustment ..... from factory set zero to 20% of full stroke range  
 Span Adjustment.....to 20% of factory set span  
 Output Signal Adjustment for Full Stroke Ranges of 120° - 240°:  
 Zero Adjustment ..... from factory set zero to 40% of full stroke range  
 Span Adjustment.....to 40% of factory set span  
 \*—when plane of pendulum motion parallel to plane of rotation within ± 3°

**ENVIRONMENTAL**  
 Enclosure .....NEMA 4/4X/6, IP 67/68  
 Hazardous Area Certification .....see ordering information  
 Operating Temperature .....-30° to 200°F (-34° to 90°C)  
 Vibration..... up to 10 G's to 2000 Hz maximum



The model IT9420 is a rugged yet simple device which provides a 4 to 20 mA current feedback signal for incline position. The heart of the IT9420 is a magnetically-damped pendulum coupled to a conductive plastic precision potentiometer. A highly linear relationship between inclination and a 4 to 20 mA output is maintained over the full range of the IT9420.

The IT9420 is easy to use: simply attach it to the object of measurement and install two wires for the current loop.

### Outline Drawing

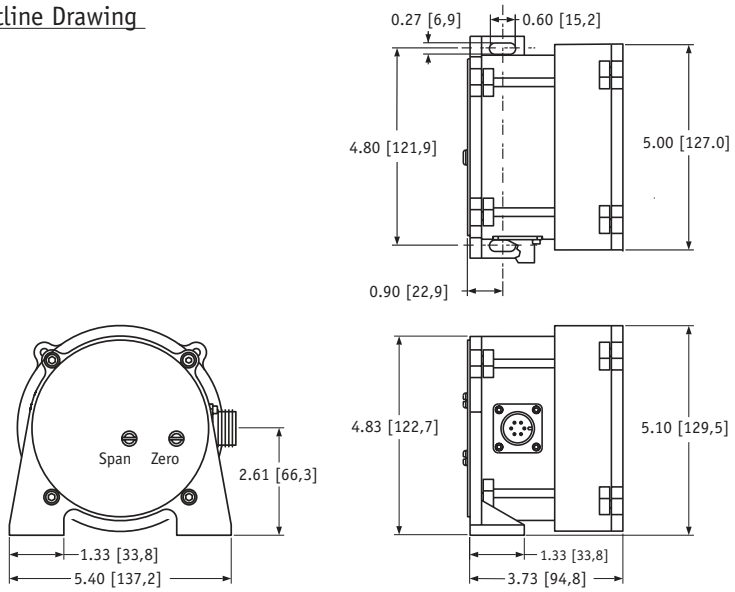

### Output Signal

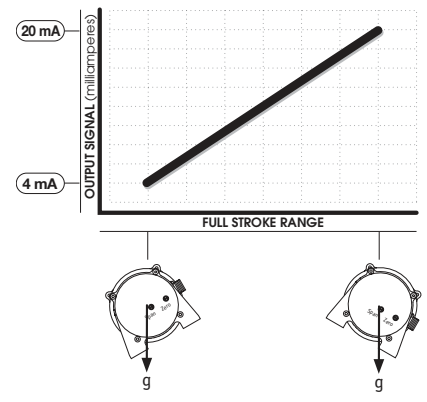

DIMENSIONS ARE IN INCHES [MM] tolerances are ±0.02 in. [±0.5 mm] unless otherwise specified  
 Celesco Transducer Products, Inc.  
 20630 Plummer Street • Chatsworth, CA 91311  
 tel: 800.423.5483 • +1.818.701.2750 • fax: +1.818.701.2799

**celesco**  
 celesco.com • info@celesco.com



**Ordering Information:**

**Model Number:**

**IT9420** - \_\_\_\_\_ - \_\_\_\_\_ - \_\_\_\_\_ - \_\_\_\_\_ - \_\_\_\_\_  
 order code:                      CW                      CCW                      A                      B                      C                      D

Sample Model Number:  
**IT9420 - 060 - 120 - 1110**

- CW clockwise rotation: 60°
- CCW counter-clockwise rotation: 120° } total rotation = 180°
- A enclosure: aluminum
- B output signal: 4 mA @ 120° CCW  
20 mA @ 60° CW
- C electrical connection: 6-pin plastic connector
- D magnetic dampening: yes

**Full Clockwise Rotation:**

CW	order code:	<b>000</b>	<b>015</b>	<b>030</b>	<b>045</b>	<b>060</b>	<b>075</b>	<b>090</b>	<b>105</b>	<b>120</b>
		0°	15°	30°	45°	60°	75°	90°	105°	120°

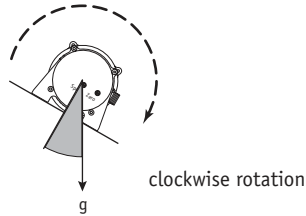

**Important--**  
 the sum of the Clockwise and Counter-Clockwise Rotations must be in the range of 45° to 240°

**Full Counter-Clockwise Rotation:**

CCW	order code:	<b>000</b>	<b>015</b>	<b>030</b>	<b>045</b>	<b>060</b>	<b>075</b>	<b>090</b>	<b>105</b>	<b>120</b>
		0°	15°	30°	45°	60°	75°	90°	105°	120°

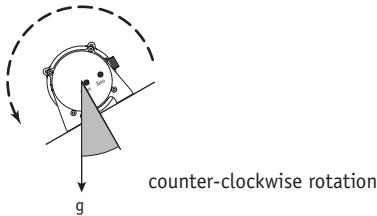

**Important--**  
 the sum of the Clockwise and Counter-Clockwise Rotations must be in the range of 45° to 240°

**Enclosure Material:**

A	order code:	<b>1</b>	<b>2</b>
		powder-painted aluminum	303 stainless steel

**Output Signal:**

B	order code:	<b>1</b>	<b>2</b>	<b>5</b>	<b>6</b>
output signal options:		4...20 mA	20...4 mA	4...20 mA	20...4 mA
input voltage:		8 – 40 vdc		14 – 32 vdc	

hazardous area certification: not certified

CSA Standard 22.2  
 Class 1  
 Groups A, B, C and D

Cenelec  
 LCIE EEx  
 ia IIC T4

**\*IMPORTANT:** intrinsically safe when powered from a CSA certified zener barrier rated 28 VDC max, 110 mA max per installation drawing#677984

**Ordering Information:**

**Electrical Connection:**

**1** **order code:** 6-pin plastic connector w/mating plug  
IP 67, NEMA 4X\*\* 6

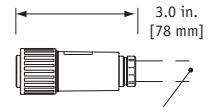

3.0 in. [78 mm]  
1/2 - 5/16" [14 - 8 mm] cable dia.  
16 AWG max conductor size  
connector: MS3102E-14S-6P  
mating plug: MS3106E-14S-6S

**2** 10-ft. [3 M] waterproof cable  
IP 67, NEMA 4X\*\* 6

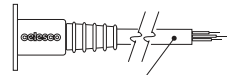

10 ft. x 0.4-in. dia. [3 M x 10 mm dia.]  
18 AWG, type SJTW

**4** 25-ft. [7.5 M] instrumentation cable  
IP 67, NEMA 6



25 ft. x 0.2-in. dia. [7,5 M x 5 mm dia.]  
24 AWG, shielded

---

**5** **order code:** 100-ft. [30 M] waterproof cable  
IP 67, NEMA 4X\*\* 6

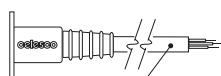

100 ft. x 0.4-in. dia. [30 M x 10 mm dia.]  
18 AWG, type SJTW

**6** 10-ft. [3 M] **pressure tested\*** waterproof cable  
IP 68, NEMA 4X\*\* 6P

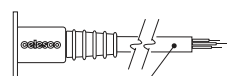

10 ft. x 0.4-in. dia. [3 M x 10 mm dia.]  
18 AWG, type SJTW

**7** 100-ft. [30 M] **pressure tested\*** waterproof cable  
IP 68, NEMA 4X\*\* 6P

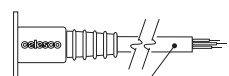

100 ft. x 0.4-in. dia. [30 M x 10 mm dia.]  
18 AWG, type SJTW

6-pin Mating Plug		Waterproof Cable		Instrumentation Cable	
pin	signal	color code	signal	color code	2-wire
A	8...40 vdc	WHITE	8...40 vdc	RED	8...40 vdc
B	4...20 mA out	BLACK	4...20 mA out	BLACK	4...20 mA out
C	-	GREEN	case ground	WHITE	n/a
D	case ground			GREEN	case ground

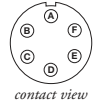

contact view

\*-Test pressure: 100 feet [30 meters] H<sub>2</sub>O (40 PSID) Test Medium: Air; Duration: 2 hours. \*\* -applies to stainless steel enclosure only.

**Dampening Option:**

**0** **order code:** with magnetic dampening

**1** without magnetic dampening

**Output Signal Selection:**

The output signal direction can be reversed at any time by simply changing the dip-switch settings found on the internal signal board. After the settings have been changed, adjustment of the Zero and Span trim pots will be required to precisely match the 4 mA and 20mA signal values to the beginning and end points of the stroke.

To gain access to the signal board, remove four Allen-Head Screws and remove end cover bracket.

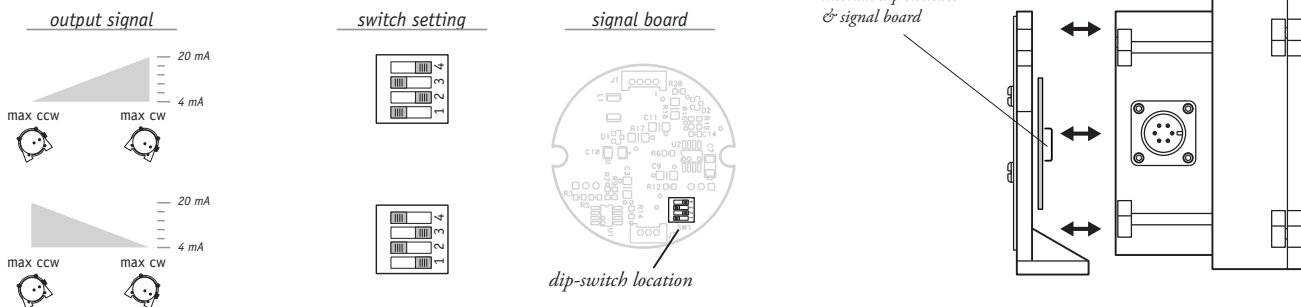

**output signal**

max ccw      max cw      20 mA  
4 mA

max ccw      max cw      20 mA  
4 mA

**switch setting**

**signal board**

dip-switch location

internal dip switches & signal board

version: 3.0 last updated: October 17, 2007